



INTELLIGENT FACILITY SOLUTIONS

Electric Works, 3 Concourse Way, Sheffield, S1 2BJ

United Kingdom: +44 (0) 114 354 0047

Eire: +353 190 36387

sales@ihdryers.co.uk

www.intelligenthanddryers.com

Automatic Soap Dispenser Installation Instructions

1. Specifications:

| | |
|----------------------------------|--|
| Dimensions (WxHxD) | 118x 265 x110 mm (4.65" x 10.4" x 4.33") |
| Soap Tank Capacity | 800 ml |
| Battery | 6 pcs of Alkaline AA (1.5V) or 1 pc of Alkaline (9V) battery |
| Detection Range | Automatic Adjustable |
| Room Temperature | 5 °C ~40 °C |
| Sensing Delay Time | 0.5 ~ 1 sec |
| Dispensed Soap Quantity | about 1.0~2.0 ml |
| Applicable Liquid Soap Viscosity | 500 ~ 3500 mPa. s(cP) |

2. Item List:

| No. | Illustration | Description | Qty |
|-----|--------------|----------------------------|-------|
| 1 | | Key | 1 Pcs |
| 2 | | Installation Instruction | 1Pc |
| 3 | | Installation Template | 1Pc |
| 4 | | Battery AA 1.5V (Optional) | 6 Pcs |
| 5 | | Plastic Dowel | 2 Pcs |
| 6 | | Fitting Screw | 2 Pcs |
| 7 | | Soap Dispenser | 1 Set |

3. Recommend Installation:

4. Before Installation:

1. Check if surface of wall is smooth and clean.
2. Note the distance between two dispensers or from wall must be $\geq 20\text{cm}$.
3. Make sure there are no obstructions below unit.

5. Installation Steps:

1. Paste the installation template at appropriate location on the wall.
2. Drill two holes dia. $\phi 6\text{mm}$, insert plastic dowels. (Fig. 1)
3. Insert two screws into dowels, and partially screw in. Remove the template. (Fig. 2)
4. USE key to unlock and remove the soap dispenser casing. (Fig. 3)
5. Remove soap tank.

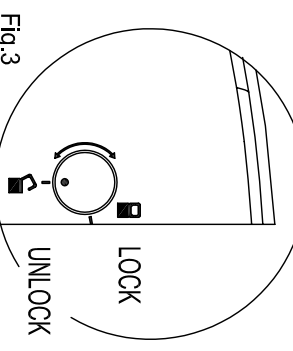
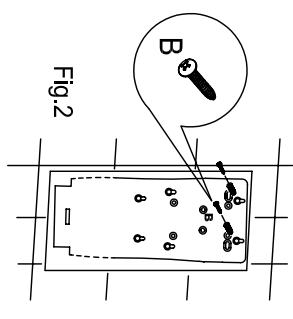
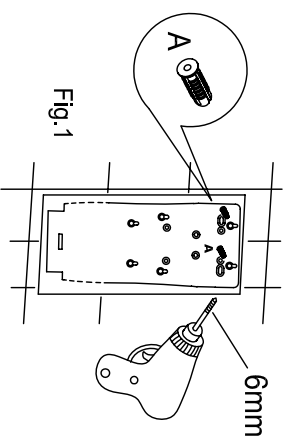

6. Hang soap dispenser onto the screws.
7. Tighten the screws. (Fig. 4)
8. Put soap tank back into housing and close casing. (Fig. 5)
9. Use key to lock casing. (Fig. 6)

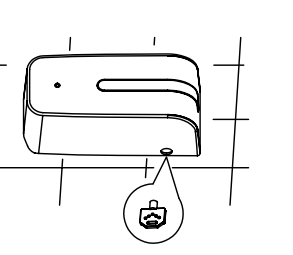
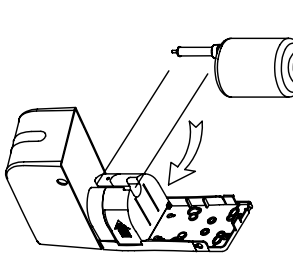
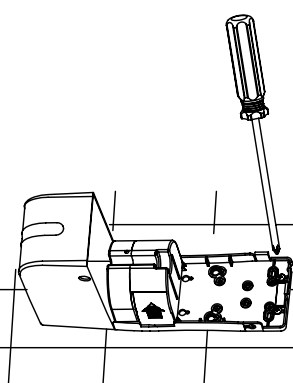

7. Installation Check:

1. Check if soap dispenser is firmly fixed to the wall.
2. Check if soap container cover is closed properly and no soap is leaking.
3. Use 6 pcs new Alkaline AA (1.5V) battery. (or alternatively 1 pc Alkaline 9V). Ensure batteries are installed properly and in the right direction (respect +/- indication).
4. Once batteries are installed and casing is closed, a red LED light will flash 4 times to indicate normal function. If casing is re-closed within 40 sec, LED will not flash.
5. Make sure soap dispenser is locked properly with the included key.

6. Operation Instructions :

- #### A. Service Instructions
1. Open casing with included key.
 2. Remove cover from battery box, put the 6 pcs of Alkaline AA 1.5V batteries into the battery box, put box back into original casing and close with cover. (Fig. 7)
 3. Remove soap container, open it and pour liquid soap into container. Close properly. Should any soap spill over the outside of the tank, clean it thoroughly. Replace clean soap container into original position, close casing and lock it.
 4. Wait 5 seconds, then place your hand under dispenser. The LED will turn on and the dispenser will release a portion of liquid soap.
 5. When used the first time, repeat that process a few times in order to fill the system.
 6. A flashing LED will indicate low battery. Exchange batteries. If problem persists, contact your dealer.

B. Users Instruction

1. Put palm of your hand below the dispenser. The sensor will activate and the motor will release 1~2 ml of liquid soap. If you need more soap, repeat the movement a few times, waiting at least 1 sec before you replace your hand under the unit. Do not scoop soap from the nozzle as this may lead to damage. (Fig. 8)
2. For refilling liquid soap into the container, always remove the container completely from the housing and fill it. **NEVER** fill when container is still in the dispenser housing. (Fig. 9)

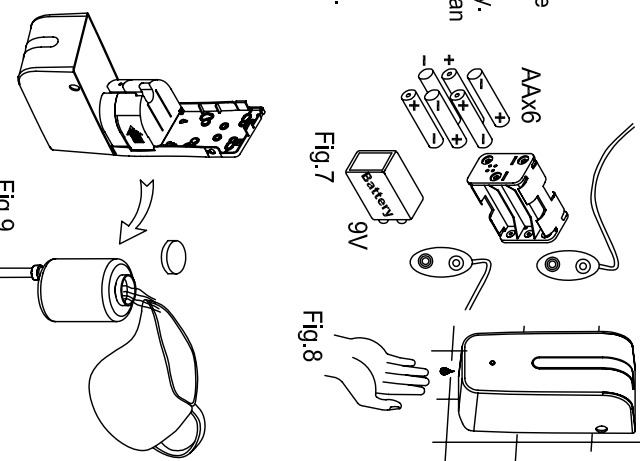

8. Adjustment of Sensor

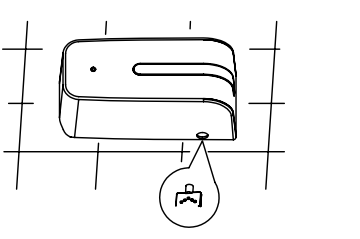

- Sensing range is self-adjusted automatically.
- Dispenser will detect the incoming object and adjust the sensing range dynamically.

9. Important Notice:

1. Ensure no light source is aimed at the sensor from below.
2. Ensure that no light reflection occurs through any object within a distance of 45cm below the sensor.
3. Use pure liquid soap only and clean the soap container properly before each re-fill. Deposits of old soap will lead to malfunction and jamming.
4. Do not dilute liquid soap and do not use grain containing soap. Respect indicated viscosity factor of liquid soap.
5. Do not immerse the soap dispenser with water or clean it under running water. This will lead to short circuit.
6. Should the dispenser be out of order and batteries have been replaced, do not attempt any repair work. Call your dealer for professional assistance.

10. Troubleshooting

| Problem | Solution |
|-------------------------------------|--|
| LED does not indicate | -Check batteries and ensure they are new and properly inserted. -Check sensor cover for stain. Clean unit properly. -Check sensor distance. If adjustment necessary refer to Pte 8. |
| LED flashes when unit is not used | -Low voltage: exchange batteries. (Fig. 7) -Sensor is activated constantly. -If above does not help, return the unit to your dealer for professional assistance. |
| No soap discharges when motor works | -Obstructed soap dispenser nozzle. Clean soap container or exchange it. -Check if soap is not liquid enough. (viscosity as per indication) |
| Insufficient soap is released | -Soap has hardened: use unit for several times or remove soap container and wash it thoroughly. -Soap nozzle is obstructed: wash soap container and use unit continuously until normal quantity is dispensed. |

